



CERAMIC

# Low Pass Filter

## LFCN-3400+

50Ω DC<sup>1</sup> to 3400 MHz

### FEATURES

- Excellent power handling, 8W
- Small size
- 5 sections
- Temperature stable
- Hermetically sealed
- LTCC construction
- Protected by U.S. Patent 6,943,646

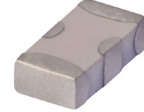

Generic photo used for illustration purposes only

CASE STYLE: FV1206

### +RoHS Compliant

The +Suffix identifies RoHS Compliance. See our web site for RoHS Compliance methodologies and qualifications

### APPLICATIONS

- Harmonic rejection
- Transmitters/receivers
- Point to point

### ELECTRICAL SPECIFICATIONS<sup>1,2</sup> AT 25°C

Parameter	F#	Frequency (MHz)	Min.	Typ.	Max.	Units	
Passband	Insertion Loss	DC-F1	DC-3400	—	—	1.5	dB
	Freq. Cut-Off	F2	3950	—	3.0	—	dB
	VSWR	DC-F1	DC-3400	—	1.2	—	:1
Stop Band	Rejection Loss	F3-F4	4300-4600	20	—	—	dB
		F4-F5	4600-7800	—	25	—	
	VSWR	F5-F6	7800-8300	—	20	—	:1
		F3-F6	4300-8300	—	17	—	

1. In Applications where DC isolation to ground is required, coupling capacitors are recommended to avoid DC leakage. Alternatively, if DC pass IN-OUT is required, Mini-Circuits' "D" suffix version of this model will support DC IN-OUT, and provide >100 MOhm isolation to ground.

2. Measured on Mini-Circuits Characterization Test Board TB-270.

### MAXIMUM RATINGS

Parameter	Ratings
Operating temperature	-55°C to 100°C
Storage temperature	-55°C to 100°C
RF Power Input <sup>3</sup>	8 W max. at 25°C

3. Passband rating, derate linearly to 3W at 100°C ambient. Permanent damage may occur if any of these limits are exceeded.

### TYPICAL FREQUENCY RESPONSE

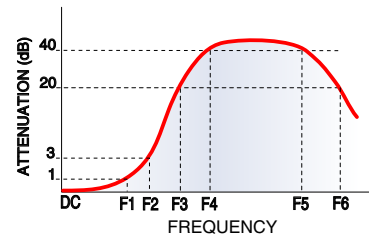

### FUNCTIONAL SCHEMATIC

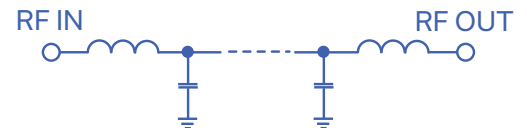

REV. E  
ECO-011761  
LFCN-3400+  
AD/CP/AM  
220128





### PIN CONNECTIONS

RF IN	1
RF OUT	3
GROUND	2,4

PRODUCT MARKING: N/A

DEMO BOARD MCL P/N: TB-270  
SUGGESTED PCB LAYOUT (PL-137)

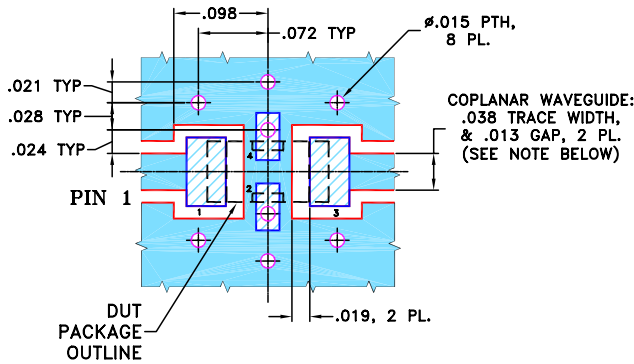

- NOTES:**
1. COPLANAR WAVEGUIDE PARAMETERS ARE SHOWN FOR ROGERS RO4350B WITH THICKNESS .020" ± .0015". COPPER: 1/2 OZ. EACH SIDE. FOR OTHER MATERIALS TRACE WIDTH & GAP MAY NEED TO BE MODIFIED.
  2. BOTTOM SIDE OF THE PCB IS CONTINUOUS GROUND PLANE.

- DENOTES PCB COPPER LAYOUT WITH SMOBC (SOLDER MASK OVER BARE COPPER)
- DENOTES COPPER LAND PATTERN FREE OF SOLDER MASK

### OUTLINE DRAWING

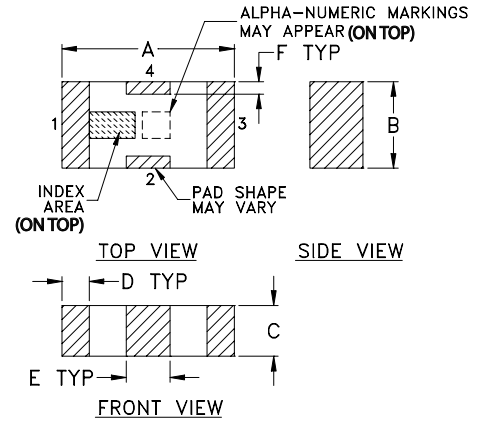

### PCB Land Pattern

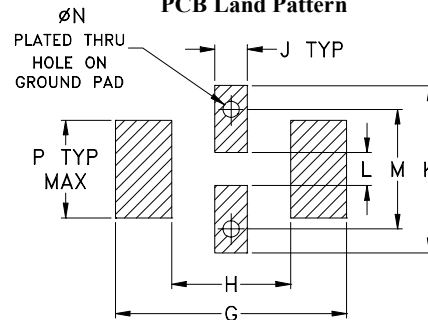

Suggested Layout,  
Tolerance to be within ±.002

### OUTLINE DIMENSIONS (Inches mm)

A	B	C	D	E	F	G	
.126	.063	.037	.020	.032	.009	.169	
3.20	1.60	0.94	0.51	0.81	0.23	4.29	
H	J	K	L	M	N	P	wt
.087	.024	.122	.024	.087	.012	.071	grams
2.21	0.61	3.10	0.61	2.21	0.30	1.80	.020

TAPE & REEL INFORMATION: F71



CERAMIC

# Low Pass Filter

## LFCN-3400+

### TYPICAL PERFORMANCE DATA AT 25°C

Frequency (MHz)	Insertion Loss (dB)	VSWR (:1)
40	0.01	1.01
100	0.03	1.01
500	0.08	1.04
1000	0.15	1.10
2000	0.31	1.32
3000	0.73	1.76
3400	1.03	1.99
3800	1.73	1.98
3950	3.04	2.21
4050	6.01	3.38
4150	12.50	6.26
4300	29.75	11.53
4600	25.02	19.32
5050	23.78	26.33
6500	24.27	28.96
7800	25.25	19.32
8300	21.39	18.11

LFCN-3400+  
INSERTION LOSS

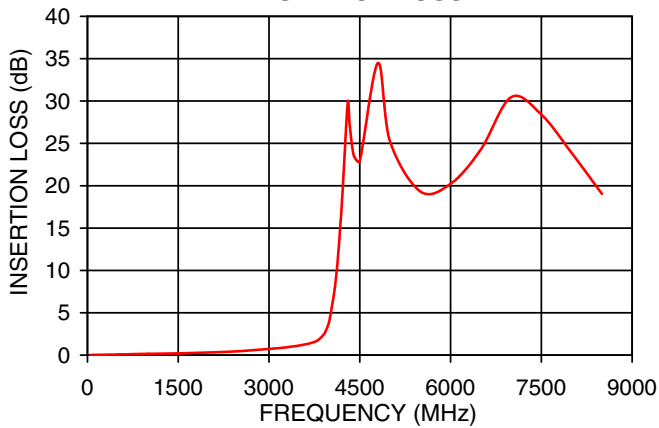

LFCN-3400+  
VSWR

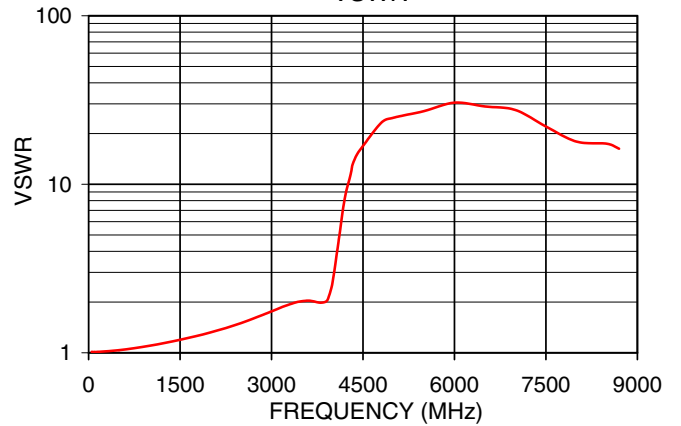

#### NOTES

- A. Performance and quality attributes and conditions not expressly stated in this specification document are intended to be excluded and do not form a part of this specification document.
- B. Electrical specifications and performance data contained in this specification document are based on Mini-Circuit's applicable established test performance criteria and measurement instructions.
- C. The parts covered by this specification document are subject to Mini-Circuits standard limited warranty and terms and conditions (collectively, "Standard Terms"); Purchasers of this part are entitled to the rights and benefits contained therein. For a full statement of the standard. Terms and the exclusive rights and remedies thereunder, please visit Mini-Circuits' website at [www.minicircuits.com/MCLStore/terms.jsp](http://www.minicircuits.com/MCLStore/terms.jsp)



# Mouser Electronics

Authorized Distributor

Click to View Pricing, Inventory, Delivery & Lifecycle Information:

[Mini-Circuits:](#)

[LFCN-3400+](#)